

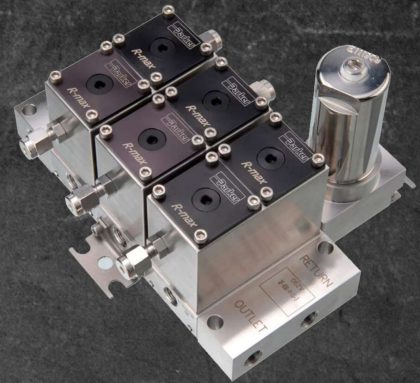

VIKING
INSTRUMENT & CONTROL LTD.

Superior Products, Exceptional Service

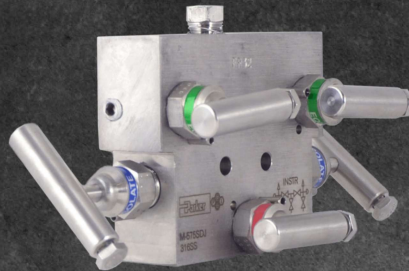

www.vikinginstrument.com

ABOUT VIKING



Offering quality products and services is our priority.

Incorporated in 1990, Viking Instrument & Control Ltd. Viking is a well established and respected provider of instrumentation and process control products for the Ontario and Alberta market. We service a wide range of industries including petrochemical refineries, analytical applications, emission monitoring, utilities, power generation, water and wastewater, manufacturing, and OEMs.

Viking represents and specializes in the following brand/product lines:

- Parker Hannifin Instrumentation (full line master distributor)
- Ashcroft Gauges, Diaphragm seals and Industrial Thermometers
- Ashcroft Switches and Transducers
- Autoclave Cone and Thread products
- Bliss Americas
- Headline Filtration
- Partek & Texloc Teflon components
- Skinner and GoldRing Solenoid Valves
- Hedland flow measurement
- Porter flow measurement and regulation
- Veriflo Regulators, Valves & CGA connections
- Multitube bundle
- Parker Parflex hose & fittings
- JMS Southeast temperature measurement
- Weka level indication
- PGI manifolds
- Parker Balston Dryers, Filtration, and Air Generators
- Techline & ZSI (Cushaclamp) installation systems

Viking has the capability of developing a product or system to meet your specifications or specific needs. Viking has Professional Engineers on staff that work with our manufacturers to help our customers specify the correct products for their application, thus improving their system performance, reducing maintenance and downtime which yields better returns.

In addition to our main office and warehouse facility in Burlington, Ontario, Viking also operates a full warehouse facility in Edmonton to service the Alberta market, and a satellite branch office in Sarnia to better serve our customers in Southwestern Ontario. To ensure a high level of quality and accuracy, we maintain a Quality Management System and ensure that our suppliers are ISO 9001 certified. We only promote and sell products from top quality manufacturers to ensure reliability, with a strong background in quality and service. Brand name products such as Parker Hannifin and Ashcroft represent the highest standards in the industry.

Viking believes in the systems approach for your projects and can provide the necessary products for final installation such as tube clamps, cabinets, hose assemblies, tubing, tools, leak detectors, and sealants. The team here at Viking will ensure that your process solutions are fully met. Starting with a strong technical field support staff, then a knowledgeable inside sales staff with engineering resources and a detail oriented inventory/shipping department, our customers will be serviced in a manner rarely seen in this modern wireless society. We look forward to working with you and your company.

MANUFACTURERS



Ashcroft

Our passion is to design, manufacture and deliver the most innovative and well-crafted pressure and temperature gauges on the planet; then back them with superior customer support. We want you to always trust the shield, so we bring five core values to work every day.



Parker Power Generation

As the world's motion control expert, Parker offers you a complete range of proven, off-the-shelf products. Engineered to work together, these products deliver streamlined systems and subsystems with exceptional quality and durability.



Finite Filter

Parker offers a complete line of Finite compressed air and gas filtration products. Compressed Air and Gas Filters, Parfit Conversion Elements, Instrumentation and Gas Sampling Filters, Steam Filters, Vacuum Exhaust Filters, Air Dryers, Drains, Gauges, Air Preparation Units, and other Accessories.



Hedland

Hedland is a manufacturer of quality flow measurement solutions for over 33 years. Since the introduction of the Hedland Variable Area Flow Meter for hydraulic oil, our product line has grown to over 15,000 flow meter models including, turbines, switches and transmitters.



Bliss Americas

Bliss Americas is a leading manufacturer of level instruments and skids, based in La Porte, TX. We supply the O&G, Petrochemical and Process & Power industries with instrumentation to measure level, pressure and flow, along with skid packages such as Modular Units, Chemical Injections, 2/3 Phase Separators, Indirect Water Bath Heaters, Gas Conditioning Regulating & Metering Systems, Filter Separators and Heater Treaters.



Phoenix Precision

Phoenix Precision manufactures a complete range of instrumentation valves including needle valves, gauge valves, and instrumentation manifolds. They also manufacture speciality valves that provide more advanced solutions for applications and the most advanced stabilizer taps in the industry.



Parker Distributor

Parker Hannifin provides highly engineered flow control instrumentation and systems. These range from tube fittings, pipe fittings, needle valves, ball valves, compact stream switching valves to modular process valve packages.



Parker Skinner

Parker Fluid Control Division, manufacturers of the Skinner and Gold Ring lines of solenoid valves and the Sinclair Collins line of process control valves. Parker's Gold Ring™ line of brass body general purpose solenoid valves include the two, three and four-way products for use in a variety of applications. The valves are used in situations where the need exists to electrically control the flow of a fluid or gas.



Autoclave Engineers

Autoclave Engineers was founded in 1945 to fill a gap in the world of high pressure and high temperature technology. Autoclave has created and produced many novel pressure vessel designs as well as made significant breakthroughs in high pressure technology.



PGI International

The PGI Division, established in 1941, serves the global energy, OEM and agricultural industries by designing, manufacturing, selling and servicing innovative high precision machined products and specialized electronic systems.



Porter

Porter engineers critical flow solutions for industrial science applications such as Laboratory Analysis, Life Science, Microelectronics, Chemicals, Solar and Fuel Cell Industries. Together, we can solve your toughest process flow challenges.



Bestobell

Bestobell has more than 50 years experience in the development and supply of cryogenic valves for industrial gas, and more than 10 years experience in providing valve solutions to the emerging LNG markets and associated industries.



Headline Filters

Headline Filters is a UK manufacturer of bonded microfibre filter elements and associated filter housings, the only major European manufacturer of this type of filter. These filters are suitable for a variety of gas and liquid applications.



Veriflo

Veriflo Division, Parker Hannifin Corporation is a leading manufacturer of precision diaphragm and bulk gas valves, regulators, and flow control components for the control and application of liquids and gases.



WEKA

WEKA is a leading manufacturer of instruments for Level Measurement of Liquids, Cryogenic Components and Special Valves. With about 60 employees our company reacts fast on clients needs.



Parker Balston

Parker Balston Filters' purification and separation technologies offer premium compressed air and gas purity, product quality, technological excellence and global support. We offer more compressed air and gas filters types and configurations than any other company.

SERVICES

For your convenience, Viking offers free consultations to assist you and your company in determining your needs. Some of the services we can provide:

Vendor Managed Inventory

This service consists of a Viking representative coming onsite for an initial consultation and working with the customer to determine inventory levels. From there, a Viking representative will come in regularly to ensure that these levels are maintained. Viking will also ensure that the customer is aware of any inventory items that may need to be increased or decreased, depending on usage.



On Site Technical Troubleshooting

With this service, a Viking representative would go onsite and discuss with the customer any issues they may be having and make recommendations on what can be done to help solve them. Depending on the issue, a manufacturer's representative or engineer may be brought in to help analyze complex issues. There is never any pressure to buy products because we believe in trying to help our customers build a strong relationship. We consistently offer our customers advice on the best practices and industry standards as well as offering alternative ways of achieving the same result while saving them money.

Gauge Fill and Diaphragm Assembly

For the convenience of our customers, Viking also offers in-house Gauge Diaphragm Assembly and Gauge Fills. After realizing the high demand for these services, we made the investment in highly specialized equipment to allow us to service different types of gauge/seal assemblies. Viking is an authorized Ashcroft gauge seal assembler.



Ashcroft factory training and bi-annual recertification ensure we meet factory specifications.

Gauge Repairs and Calibration

Gauges aren't indestructible and we understand that, over-pressurization, vibration, pulsation or accidental damage are all part of the real world for pressure gauges. Viking will bench test your damaged gauge and provide an analysis of whether it is a repair or should be replaced. Viking has the equipment to properly test and calibrate your gauges. If required we can also provide a third party calibration certification.

Custom Hose Assembly

Viking has the in-house capability to manufacture custom hose assemblies for various applications, with end connections as required by our customer's process. This in-house service, dramatically reduces lead time which is always an issue with hose assemblies.

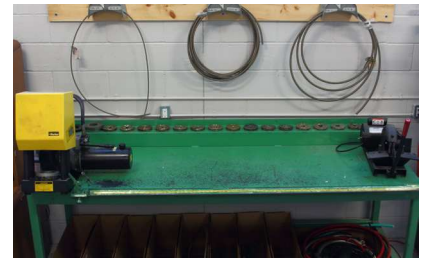

Custom System Fabrication

System fabrication is another service Viking provides. This consists of taking a variety of different products or components and putting them together in a predetermined way, according to either the engineer's diagrams or the customer's specific instructions.

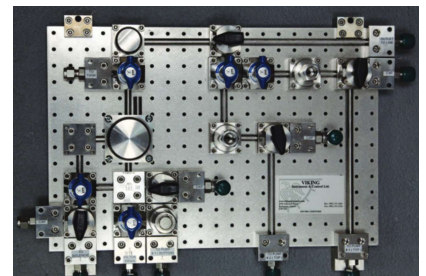

These systems range from something as simple as instruments in a weatherproof heated box to prevent freezing, or as complex as a full sampling panel. This helps the customer reduce labour, installation time and/or downtime with these ready to go assemblies.

TRAINING SEMINARS

Autoclave Cone and Thread Classes

Specific to the Autoclave product line, this seminar is designed for high pressure applications (15,000-150,000 PSI), which require a coned and threaded connection on the tubing. In this class, our instructor will teach safety, how to properly cone and thread the tubing, as well as the correct fitting make up procedures.



Manifold Training

We like to keep our customers feeling confident in their purchase decisions, so we also offer product training on our manifolds where we show sample products, give advice on how/where to use each manifold, provide customers with knowledge on industry standards, flow coefficient, temperature and pressure curves, as well as what to keep in mind when buying/specifying manifolds.



Tube Bending Classes – Installation Training

This session will educate our customers on the proper tube bending techniques and best practices. In addition, participants will also learn about tube gain, and how to measure and prepare for a tube bend through extensive hands-on training.



Tube Fabrication Course

This is an installation course that teaches customers how to perform proper fitting make up procedures, and how to select the right tubing using temperature and pressure charts. We will also go over industry standards and best practices, inform customers about safety and how to select the right materials to avoid galling. When this course is completed in conjunction with our tube bending class, customers will receive an industrial certification.

Regulator Seminars

Viking offers seminars to our customers to better educate them on the products they use. During the product training for our Regulators, we will disassemble the unit, explain the different parts and mechanisms, and teach our customers what to look for when choosing a good regulator.

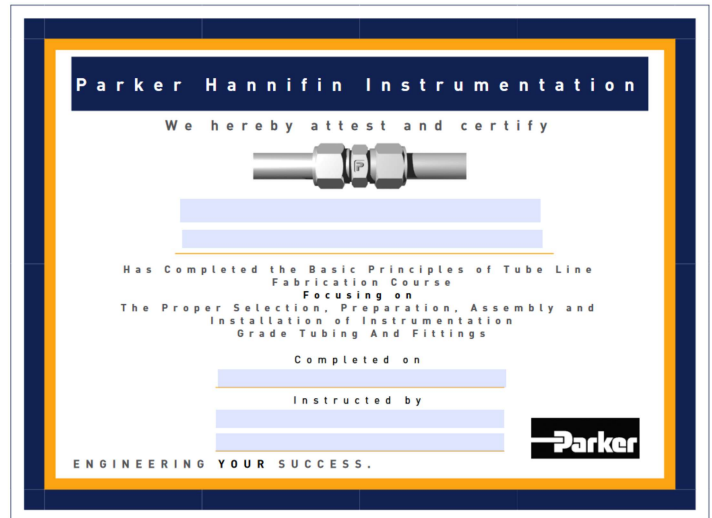

Valve Training

Having a vast knowledge of various types of valves, here at Viking we also offer product training on our valves. We will show different samples, and tell our customers about the best application use for each specific valve. In addition, we'll provide knowledge on flow coefficient, temperature and pressure curves, industry standards, as well as what to keep in mind when buying/specifying valves.



Gauge Training

We feel providing our customers with the knowledge they need is necessary, which is why at Viking, we like to make it a priority to ensure our customers are informed. For this reason, we offer product training on the gauge lines that we carry. During these sessions, we perform demonstrations, show samples and are go over any questions our customers have in order to select the proper gauge.



ASHCROFT

Bimetal Thermometers



The complete line of Ashcroft industrial bimetal thermometers provides quality choices for your temperature applications. Each instrument is manufactured to a standard accuracy of 1% of span (ASME B40.3, Grade A) traceable to NIST. Available in dial sizes of 2", 3" and 5", and a number of different styles including field adjustable, hermetically sealed, and liquid filled.

Diaphragm Seals



Diaphragm seals are used to isolate the media from the instrument due to many reasons including corrosive services, slurry and process prone to clogging, suspended solids, and safety. When choosing a diaphragm seal there are many different models to choose from, and each has a number of options for material of construction and fill to ensure proper media compatibility.

Differential Gauges



With a wide selection of differential gauges to choose from we have a solution to meet most applications. We have gauges capable of handling high static line pressures while measuring differentials in inches of water. There are a number of different case materials and styles to choose from, some models also include the ability to add switches.

Pressure and Temperature Switches



Ashcroft pressure and temperature switches are designed for tough industrial and OEM applications requiring a durable, high-quality switch. Available with single or dual independently adjustable setpoints, both fixed and adjustable from 15%-100% of range. Available with a number of classifications including UL, CSA, and NACE. With a wide array of optional switch elements, seals, and enclosures we have a switch for virtually all process, industrial and OEM applications.

ISO Rings



Available in both wafer and bolt through styles, the Ashcroft ISO Rings are adaptable to a variety of process conditions and applications. A 360-degree flexible inner cylinder means no clogging, assuring reliable and accurate pressure readings. Available in sizes from 2" to 20" it can be used in any pressure within the limitations of ASME classes 150 and 300, and even in most vacuum applications.

Duratemp Thermometers



Duratemp gas actuated thermometers have an exclusive movementless design which is resistant to shock and vibration. No gears to wear or misalign results in increased instrument life. Available in a number of different dial styles, Duratemp thermometers are accurate to 1% of full scale, are mercury free and come either direct mounted or with a bulb and capillary.

Stainless Steel Gauges



Ashcroft's line of stainless steel gauges come in a wide range of dial sizes and accuracies so we are sure to have a gauge to meet your needs. Our stainless steel gauges are available with a selection of dial sizes and end connections including tube stub and panel mounting brackets. Our line of stainless steel gauges are capable of handling applications from full vacuum to 100,00 PSI.

Process Gauges



Ashcroft Process gauges are made to ASME B40.100 specifications and are accurate to 0.5% of span. We have a large selection of bourdon tube materials, case materials and dial sizes to meet your process needs. The line of process gauges uses Teflon coated 400 series stainless steel for rotary movement parts for longer life. All process gauges are available in dry, liquid filled and Performance Plus! as well as a large selection of other options.

Test Instruments



Ashcroft precision test instruments yield consistent, reliable accuracy through the use of state-of-the-art precision machining. There is test equipment to suit any of your needs including analog, digital, handheld units, dead weight testers, and volume controllers. The Ashcroft line of test equipment is able to handle applications up to 100,000 PSI with a high degree of accuracy up to +/- 0.025% of full scale.

Pressure Transmitters and Transducers



We carry a complete line of Ashcroft pressure transmitters and transducers to meet the needs of your applications including commercial, OEM, and industrial. Available with a wide selection of pressure connections, electrical terminals, accuracies to 0.25% of full scale and pressures from vacuum to 20,000 PSI.

Thermowells



Used to separate your process media from your instruments, thermowells come in a wide range of sizes and connections to meet your needs. In order to be compatible with your media we have a large selection of materials to choose from, and are available with a number of process connections including flanged, welded, and sanitary.

Commercial Gauges



Made to top quality Ashcroft standards, we offer a complete line of economical gauges to meet your application needs. Whether your function is fire protection, ammonia service, refrigeration, or a large number of specialty applications we have a wide selection of products suitable for your requirements. There are a number of case styles, accuracies, and wetted parts to choose from.

Digital Gauges



Large five digit LCD displays, make our multi-functional digital gauges perfect for a wide range of applications. These gauges come complete with easy to use menus, multiple units of measure, different backlite display options, and memory capabilities. Our digital line of products are capable of meeting a number of different certifications including, CSA, CE, FM, NEMA, and UL.



BALSTON FILTRATION



Coalescing Compressed Air Filters

Balston Coalescing Compressed Air Filters protect your equipment and delicate instruments from the dirt, water, and oil usually found in compressed air. Balston

Coalescing Filters remove these contaminants at a very high efficiency up to 99.99% for 0.01 micron particles and droplets.



Compressed Air Filters

Liquid releases from the filter cartridge to an automatic drain as rapidly as it enters the filter. This allows a Balston Coalescing Filter to continue removing liquids for an unlimited time without loss of

efficiency or flow capacity. Select 1/4" to 2" line filters come with a lifetime (20 year) warranty which guarantees the product against defects and other failures.



Natural Gas Filters

Balston high flow rate compressed gas filters offer exceptionally high efficiency coalescing filtration of compressed gas at high flow rates. Specifically designed to remove suspended liquids and

dirt from pipeline natural gas, the housings are ASME Code Stamped up to 1440 psig (100 barg). Equipped with Balston Microfibre® Grade DX Disposable Filter Cartridges, the filters are rated at 93% retention of 0.01 micron.



Stainless Steel Sintered Metal Filter

The Balston Stainless Steel Sintered Metal Filter is suitable for applications which require a durable, low maintenance reusable stainless steel filter. The

filter cartridge is constructed of 316 stainless steel with two molded Viton gaskets. It may be installed in select Balston filter housings which are designed to accommodate an 050-11, 100-12, and 100-25 size filter cartridge. The Balston Stainless Steel Sintered Metal Filters may be used in liquid or gas service, to filter particulate sized from 5 micron to 100 micron, depending on the grade of the filter used.



Compressed Air Dryers

Balston offers both membrane and PSA technology. Balston Membrane Air Dryers combine superior coalescing technology with a proven, innovative membrane system to supply clean,

dry compressed air with dewpoints as low as -40°F (-40°C).



Balston Gas and Liquid Sample

Analyzer Filters protect analyzers from sample impurities by removing solids and liquids from gases with 99.99999+% efficiency at 0.01 micron. Balston Sample

Filters offer liquid filtration to 1 micron or lower. Composed of borosilicate glass microfibers with a resin binder, Balston sample filters are inert to most any gas or liquid.



OEM Disposable Inline Filters

Balston branded filter cartridges offer high efficiency filtration rating, consistency in quality and performance, as well as robustness and durability.

- Prevent cross-contamination of samples
- Pressure ratings up to 125 psig (8.62 barg)
- Temperature to 275°F (135°C)
- Completely disposable, constructed of recyclable plastics
- Replacement Elements - replacementtubes-X-Q-H



Steam Filters for Food Industry

Balston Series SR Filters are in full compliance with the requirements of the US Food, Drug and Cosmetic Act. They also meet the federal regulations for Indirect

Food Additives for use as Basic Components of Repeated Use Food Contact Surfaces as specified in 21 CFR Part 177, and Current Good Manufacturing Practices, 21 CFR Part 110. These filters have been accepted by the USDA for use in federally inspected meat and poultry plants. Balston Steam Filters are in full compliance with the 3A Accepted Practices (Number 609-04) for producing steam of culinary quality. They are also in full compliance with the requirements of the Health Protection Branch of Health and Welfare Canada.



Air Generators

A steady, safe supply of high-purity gases is essential to guarantee precise results in analytical techniques such as chromatography, spectroscopy, and spectrometry. Gas purity can

vary significantly from cylinder to cylinder, and impurities can be introduced via pipework during a changeover. In contrast, on-site gas generators supply consistently high-purity gas, prevent variations and ensure ultra-sensitive analysis, every time.



Low Flow Compact Compressed Air Filters

The source of oil in compressed air is the compressor lubricant. The common plant problems resulting from oil in the air are caused by liquid oil depositing in valves,

instrument control surfaces, and other critical points in the air distribution system.



Stainless Steel Compressed Filter Elements

Balston Compressed Air Filters protect your equipment and delicate instruments from the dirt, water, and oil usually found in

compressed air and other gases. These filters will remove contaminants at a very high efficiency - up to 99.99% for 0.01-micron particles and droplets. Liquid releases from the filter cartridge to an automatic drain as rapidly as it enters the filter. This allows the filter to continue removing liquids for an unlimited time without loss of efficiency or flow capacity.



Vacuum Pump and Exhaust Filters

Balston Vacuum Pump Exhaust Filters remove 99.9% of 0.1-micron oil mist and smoke particles. Balston Grade 30 Vacuum Pump Inlet Filters remove 90% of all

0.1-micron particles and droplets. Balston Grade 102 Vacuum Pump Inlet Filters prevent oil back-streaming from the pump to the evacuated chamber and protect the pump from damage by submicron particles (at relatively low concentrations).

PRODUCTS

FITTINGS



CPI™ Fittings (Catalog 4230/4233)

- Three piece simple design to work on all instrumentation grade tubing.
- Molybdenum Disulfide coated nuts to prevent galling and provide lubrication.
- Single ferrule system treated with Suparcase™ technology to insure sealing.



A-LOK® Fittings (Catalog 4230/4233)

- Industry standard design for all instrumentation grade tubing.
- Silver coated threads to reduce galling.



MPI™ Fittings (Catalog 4234)

- Compression fitting for medium pressure applications up to 15,000 psi (1034 bar).
- Inverted body and nut design for added strength with thick-wall tubing.
- Longer thread area for improved performance and resistance to vibration.



PARKER Autoclave Engineers®

- High pressure fittings.
- Coned-and-threaded connection.
- Tubing sizes are 1/4", 5/16", 3/8", 9/16" and 1".



Phastite® (Catalogue 4235-PH)

- Option for welded systems.
- Simple assembly process provides high integrity connections, first time every time.
- Installation time reduced to seconds.



Miniature Valves

Parker's range of miniature valves meet the needs of the most demanding gas flow applications and are suitable for analytical chemistry and clinical diagnostics. Our broad selection of miniature valves is known for dependable performance with the capability to handle high pressure and high temperatures.

BALL/PLUG VALVES



MB Series (Catalog 4121-MB)

- One piece compact barstock design.
- Center off position for 3-way
- 2-way, inline, angle; 3-way, 4-way and 5-way.



B Series (Catalog 4121-BV)

- 2-way, 3-way diverting or spring loaded 3-way selector designs.
- Wide temperature application range -65°F (18°C) to +450°F (232°C).
- Rated for up to 6000 psi (413.7 bar).



HB Series (Catalog 4121-BV)

- Compact FNPT version for tight work areas.
- Full operating pressure in any port.



PR Series (Catalog 4121-BV)

- Low operating torque.
- Optional locking device, downstream vent and metal tee handles.



Pneumatic/Electric Actuators (Catalog 4121-BV)

- 60 Series pneumatic actuators provide 90° and 180° rotation in both double acting and spring return models.



HBV Series (Catalog 4190-HBV)

- Suitable for the most demanding applications in the oil, gas and process control industries.
- Integral compression ends available, eliminating taper threads and thread sealants.
- Two piece barstock design reduces body leakage path.

NEEDLE VALVES



V Series (Catalog 4110-NV)

- For positive leak tight shut-off and regulation of fluids.
- Choice of three stem types.



VQ Series (Catalog 4110-NV)

- In-line and angle patterns.
- Panel mountable.



U Series (Catalog 4110-NV)

- Stem packing below the threads isolates the thread lubricant from the flow.
- Severe service applications.



HNV Series (Catalog 4190-NV)

- Compact needle valves.
- For applications up to 10,000 psi (690 bar).

DIAPHRAGM VALVES



NV17 (Bulletin 25000222)

- General purpose, high cycle, compact valve.
- For regulator outlet valve, gas control panels and analyzer sampling system applications.

CHECK AND RELIEF VALVES



Check Valve

Parker C Series Check Valves are designed for uni-directional flow control of fluids and gases in industries such as chemical processing, oil and gas production and transmission, pharmaceutical, pulp and paper, power and utilities.



Relief Valve

Parker RH4 Relief Valves are designed such that when the upstream pressure exceeds the closing force exerted by the spring, the lower stem opens, permitting flow through the valve. Flow through the valve increases proportionately to the increase in upstream pressure.

PARFLARE PFA TUBE FITTINGS



Parflare PFA Tube Fittings

- Parflare fittings provide low dead volume, which decreases the possibility of particle entrapment and bacterial growth.



Pargrip PFA Tube Fittings

- Perfect for applications where ease of assembly is a requirement. Grooved tubing is not required.

PRODUCTS

AUTOCLAVE ENGINEERS RESEARCH SYSTEMS



Parker Autoclave Engineer Research was founded by Fred Gasche in 1945 to fill a gap in the world of high pressure and high temperature technology. Parker Autoclave Engineers has

created and produced many novel pressure vessel designs as well as made significant break throughs in high pressure technology such as the MagneDrive® magnetically coupled agitator.

QUICK COUPLERS



Parker offers quick connect and quick disconnect couplings for hydraulic, pneumatic and medical applications. Parker quick disconnect

couplings are used to connect and/or disconnect hydraulic or pneumatic lines quickly and easily without the use of tools. Parker offers quick disconnect couplings in a wide variety of styles, such as non spill and double-shut-off quick couplings, and connect under pressure quick couplings.

CRYOGENIC VALVES



- WEKA AG is a leading manufacturer of Cryogenic-Components for the application of liquefied, cryogenic gases.
- Cryogenic Valves (Shut off and Control Valves, Vacuum Jacketed and also for Cold Box Mounting).

- Special Valves for any Cryogenic Applications.
- Bellows Sealed Valves (up to PN600).
- Cryogenic Transferlines and Couplings Space Cryogenic Components.
- Custom made Cryogenic Components e. g. Cryostats and Ejectors.

DIAPHRAM SEALS



Diaphragm Seals are used to separate the pressure instrument from the process, to protect the vulnerable measuring element. Bad-

otherm has over 30 years' experience in mounting and filling Diaphragm Seals with pressure instruments, and specializes in the assembly with pressure transmitters.

AUTOCLAVE FITTINGS, VALVES AND TUBING



- Low Pressure Instrumentation Products to 15,000 psi (1035 bar)
- Medium Pressure Instrumentation Products to 20,000 psi (1380 bar)
- High Pressure Instrumentation Products to 60,000 psi (4135 bar)
- Ultra High Pressure Instrumentation Products to 150,000 psi (10350 bar)

BRASS AND PLASTICS



Parker has a complete line of brass and thermoplastic components for fluid and gas applications including the following product categories:

- Compression style for pneumatic and transportation
- Push to connect for pneumatic and transportation
- Thermoplastic fittings and valves
- Flare fittings
- Adapters
- Barbed fittings

SIGHT FLOW INDICATOR



Bliss Sight Flow Indicators provide an effective way to view the condition of liquids or solids flowing through pipelines at most any flow, pressure,

or temperature, a major advantage over electronic devices where it is difficult to distinguish if there is a flow problem or malfunction in the device. Bliss Sight Flow Indicators assure a direct and positive indication of flow rate, flow direction and condition of the medium being transported plus enable a means of inspecting pipelines for dirt, scale and foreign matter.

MAGNETIC LEVEL GAUGE



Magnetic Level Gauges are high-accuracy, low-maintenance instruments. They provide non-invasive level indication while eliminating leak points and fugitive emissions. Their robust design is ideal for high temperatures, high

pressures and corrosive services. Bliss gauges are easy to install and require no extra piping in most applications.

GOLDRING AND SKINNER SOLENOID VALVES



Parker's Gold Ring™ and Skinner general purpose solenoid valves include the two, three and four-way products for use in a variety of applications. The valves are used in

situations where the need exists to electrically control the flow of a fluid or gas. Available in a number of functions including normally closed, normally open, and universal three-way valves.

LUBRICATED PLUG VALVE



Brdr. Christensens is a world leader in the creation of lubricated plug valves. We deliver valves to all the world's major oil and gas companies, where

they're used on land sites, offshore, and on large gas transmission and compressor stations.

GAUGE VALVE



Recommended for use with Bliss Liquid Level Gauge Series and is compatible with all armored flat glass Liquid Level Gauges. A Stainless

steel ball check located upstream of the seal instantly shuts off flow in case of gauge glass break.

GLASS LEVEL GAUGES



Bliss Level Gauge standard construction includes a solid one-piece chamber machined from carbon steel with covers, toughened glass

and chrome molybdenum bolts and nuts. All metal parts are rust proofed. Recessed gasket seat prevent movement and insure leak-free service.

INSTRUMENT CHAMBER



Our Instrument Chambers are designed to the ASME B31.3 standards, and are Pressure Equipment Directive (PED) compliant.

They have weld neck flanges and full penetration welds in accordance with EN ISO 15614-1:2004, and ASME Boiler and Pressure Vessel Code Section IX are used throughout. There are 2 designs available: the Standard Design and T-piece Design.

PGI - PRESSURE-CORE® SEAL

Product Features:

- Leak-Free Performance
- Unmatched 7 Year Warranty
- No Adjustments or Maintenance Requirements
- Meets EPA Method 21 requirements

Product Make-up:

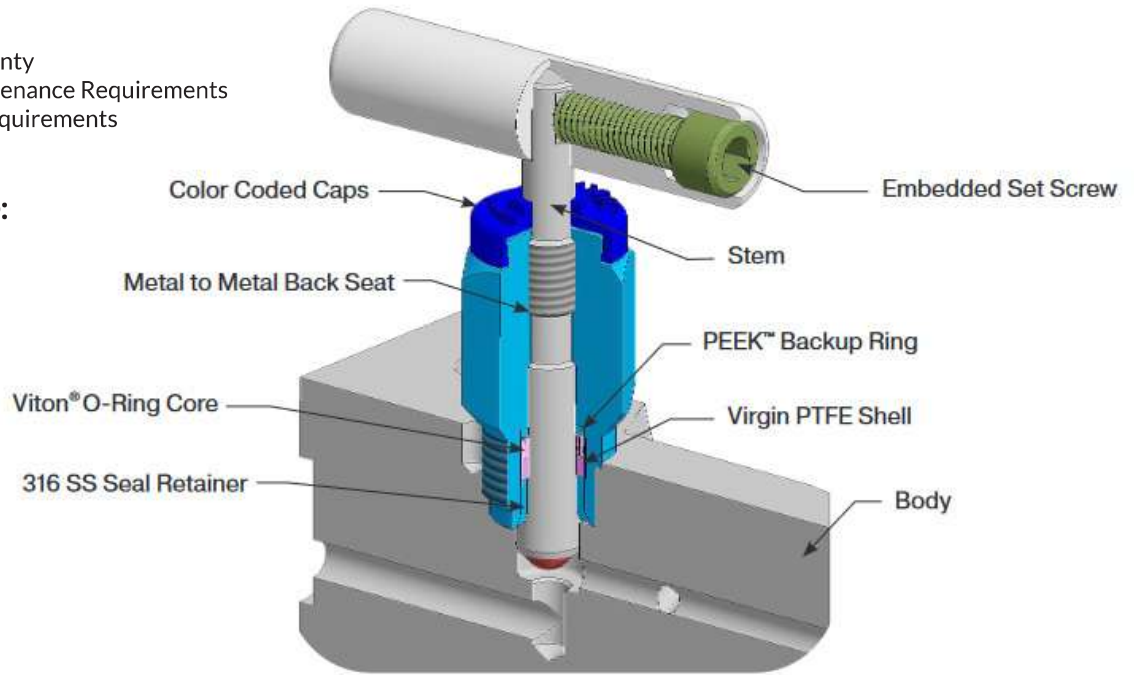

Pressure-Core® Seal

How we do it!

The Pressure-Core® Seal consists of an outer PTFE shell with an elliptical shaped Viton® O-Ring core. The encapsulated core is “live-loaded” and provides constant outward pressure against the PTFE shell, which flexes under pressure like an O-Ring. The PTFE shell offers the desired chemical resistance without periodic gland tightening as in conventional designs.



FAR SUPERIOR TO ANY SOLUTION IN THE MARKET TODAY!

Fugitive Emissions Test Results

See for yourself how our Pressure-Core® not only outperforms the competition, but sets a new industry standard...

Test Procedures

Valves mechanically cycled 50 times (full open to full close) at 1,000 PSI methane, then heated to 400°F and air cooled to ambient. Procedure repeated until failure.

Failure Criteria

100 PPM leak*

*Competition's Emission Seal Warranty

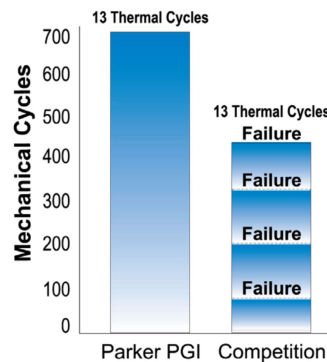

Test Results

Parker: The Pressure-Core® Seal successfully completed 694 mechanical cycles and 13 thermal cycles. Maximum leakage throughout testing was 40 PPM.

Competition: The competition's “low emissions” graphite design failed on the 89th mechanical cycle and on average every 125 cycles throughout the testing. Repeated maintenance was required between each failure to readjust the valve packing.

MANIFOLDS

PGI

Instrument and Multi-Port Valves



Parker's Instrument and Multi-Port Valves are designed for bubble tight shut-off and maximum reliability. This makes them both an excellent choice for

most service conditions. They are versatile and can be used for multiple positioning of gauges, instruments and pressure switches.

2-Valve Manifolds



Parker's wide variety of 2-Valve Manifolds permit the user to select and hook-up to virtually any pressure transmitter, gauge or switch. The controlled vent provides the option of venting to

atmosphere or piping to a collector, depending on the media.

3-Valve Manifolds



Parker's selection of 3-Valve Manifolds permit the user to select and hook-up any transmitter. A variety of 3-Valve Manifold styles are available with controlled vents for use where venting to

atmosphere is not permitted and piping to collectors or vessels is required.

5-Valve Manifolds



Parker's 5-Valve Manifolds permit the user to select and hook-up any chart recorder, transmitter or EFM for gas applications. Features WIDE Pattern™ technology, a unique configuration for "no finger

pinching" operation of all five valves. Parker's Versa-Mount bracket allows the easy mounting of most 2, 3 and 5-Valve Manifolds to a 2" pipe stand or wall-mounted application.

Power and Root Valves



All Parker Power Valves conform to ANSI B31.1 Power Piping Code. Valve temperature and pressure ratings are ASME Class 2500, and materials conform to those listed in the ASTM specifications.

Hydrostatic testing is performed in accordance with MSS-SP-61 and includes a shell test at 1.5 times the rated design pressure and seat(s) leakage test at 1.1 times the maximum pressure rating.



Direct-Mount System

Parker is the recognized industry leader in the close coupling of manifold systems. Pioneered by Parker in 1988, Direct-Mount® Systems can minimize or eliminate Gauge Line Error (GLE), resulting in more accurate measurement. Dielectric isolators are available for stabilized connectors and manifolds. Parker also offers the Direct-Mount® Duo™ Stabilized Connector with Integral Block Valves.



Wellhead Fitting and Valve Components

Parker's Wellhead Fittings and Valve Components allow for the proper lubrication of essential equipment, the relieving of pressure from inside closed mechanical systems and provides sealing methods to the wellhead and valve ports.

- The standard design directs the flow of lubricant through the center of the spring to reduce "pack-off"

PHEONIX

Double Block and Bleed – Severe Service



The double block and bleed valve (DBB) is designed for high temperature and severe service applications. This globe pattern provides maximum shut-off using a ceramic ball tip stem on the process valve and a needle tip stem on the bleed valve. Phoenix offers this valve in a variety of construction materials, end connections and configurations, including configurations with multiple cross ports.

Bellows Seal Valve



The bellows seal valve is designed with a metal bellows between the stem and body as the primary seal, which provides a hermetical metal boundary to the process eliminating two leaking paths

compared to traditional packed seal valves. Zero fugitive emission is achieved by this configuration. A standard Grafoil™ backup packing and a backseating valve stem provide additional safety.

Block and Bleed



The block and bleed valve is designed for use with pressure gauges, pressure transmitters, or pressure switches. The BB6H features a two-valve block and bleed design complete with a ¼" FNPT vent/calibration port. The BB6H is constructed from barstock and features robust stems. This design ensures a bubble tight seal. Bonnets are pinned for security.

PARKER IPDE

Pro-Bloc® (Catalog 4190-FP)



- Compact double block and bleed valves, featuring needle or ball valve options.
- Reducing installations cost while improving safety through a reduction in leak paths.

Monoflange

(Catalog 4190-FP)



- Compact double block and bleed valves, featuring needle valves.
- Reducing installations cost while improving safety through a reduction in leak paths.

H-Series

(Catalog 4190-PM/4190-FM)



- A comprehensive range of 2, 3 and 5 valve manifolds for pressure and flow measurement applications.
- Available with integral PTFree® connections, reducing leakpaths and installation cost.

Monoball Valve



Parker's wafer style valve Monoball is a lightweight ball valve in a flange design that either isolates an instrument or sits between two process flanges to isolate a process line.

Monoflange-style construction makes this valve lighter and more compact than conventional flange-to-flange mounted ball valves. This makes it ideal for space and weight sensitive applications such as offshore platforms, as well as the many common isolation requirements.

Hi-Pro distribution manifolds



Parker's Hi-Pro distribution manifolds are designed for applications that use liquid or gas, low temperature steam and hydraulic actuation. The pressure rating of these manifolds is dictated by the inlet/outlet Flange Class or the thread connection. These Hi-Pro distribution manifolds feature an ergonomic vinyl sleeve on the valve handle to provide positive grip and ensure ease of operation. Each nut has an innovative domed design, which prevents ingress of moisture and contamination of the thread, therefore preventing corrosion.

ANALYTICAL PRODUCTS

PRESSURE REGULATORS



IR4000 Series

(Bulletins 25000226, 25000223, 25000233)

- Internally threadless design
- Convoluted Hastelloy C-22® diaphragm.
- Available in 316L SST, Brass, Hastelloy C-22®, Monel®.



IR6000 Series

(Bulletins 25000141, 25000224, 25000227)

- Dual stage regulator.
- Internally threadless design.
- Convoluted Hastelloy C-22® diaphragm.
- Available in 316L SST, Brass, Hastelloy C-22®, Monel®.

VAPOURIZING REGULATORS



AVR3 (Bulletin 25000138)

- Steam heat design.
- Internally threadless design.
- Available in 316L SST, Monel®.



AVR4 (Bulletin 25000137)

- Electrical heat design.
- Field serviceable heat transfer element.
- CSA, Cenelec, and ATEX certified.
- Internally threadless design.

BACK PRESSURE REGULATORS



ABP1 (Bulletin 25000021)

- Reduce contamination and accurately control back pressure.
- Internally threadless design.
- Convoluted Hastelloy C-22® diaphragm.

CHANGEOVER SYSTEMS



Maintains continuous gas delivery from two separate sources; allows maximum cylinder gas usage from one source before automatically switching to the second.

DIAPHRAGM VALVES



FS190 (Bulletin 25000034)

- Excess flow shut-off valve.
- Manual or pneumatic actuation.
- Non-attitude sensitive.
- Six pressure/flow limit settings.

Sample probes



Parker's Sample Probes

The perfect choice for spot or composite sampling. The Probes are available in single flow, dual flow and hot tap, all with 316 SS construction. Each Probe can be customized with numerous inlet and outlet configurations.

Gas Flow Controllers



SC423XL Gas Flow Controller

The SC423XL Series Flow Controller is a unique device which supplies a constant flow with a self correcting action to compensate for changes in downstream pressure. The SC423XL was designed for air and analyzer sampling systems which require very low flow rates (less than 10 scc/m). Connected to a vacuum cylinder, the SC423XL provides consistent flow control despite changes in the vacuum.

R-Max



The Parker Gen II R-max™

Multi-functional system capable of integrating both stream switching and filtering into one unique compact assembly. The system is designed to control both gases and liquids in analytical systems ranging from vacuum to 500 psig (34 bar) while requiring only 65 psig (5 bar) actuating air pressure.

Intraflow

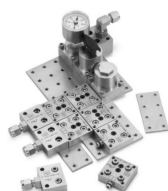

Parker IntraFlow™

Substrate fittings have been developed specifically for analytical, lab and other complex general purpose instrumentation flow control systems. ISA/ANSI SP76.00.02 compliant, Parker IntraFlow™ fittings provide maximum flexibility with minimal space requirements. All flowpaths, regardless of direction, are maintained on a single plane within the system as there are no lower level manifold blocks required.

VENT MASTER



Parker's Vent Master™

Designed to isolate the analyzer from fluctuating outlet pressures by controlling the pressure of the collection header and pumping the effluent sample gases into the fluctuating return system.

EXPRESS REGULATORS

Parker Regulator Supply Partnership Program



SCOPE:

The program has been developed to provide high quality Parker IR4000 Single Stage and IR6000 Dual Stage Series Regulators with a premium delivery schedule.

Viking Instruments, a Certified Parker Distributorship, has been designated to hold necessary regulator inventory for satisfying market demand. As the Parker Canadian Regulator Distributor, Viking is equipped to service all provinces within Canada.

FEATURES:

- Based on proven regulator technology
- Multiple outlet range options available
- Reduced delivery times (1 week)
- Multiple body porting options
- Regional support and inventory

PORTING OPTIONS

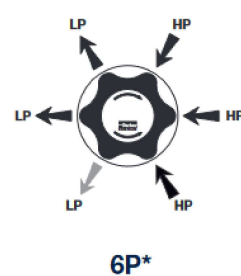
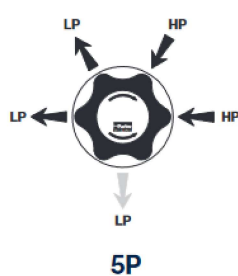
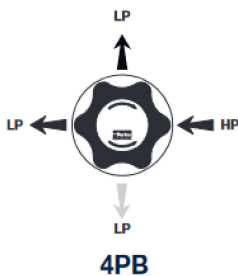
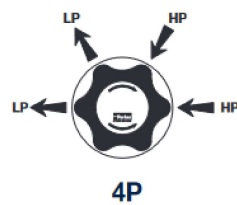
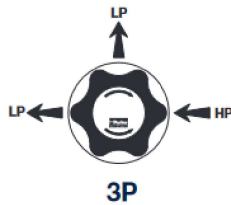
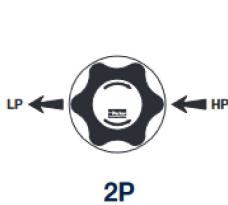

Parker IR4000 Series



Parker IR6000 Series

PRESSURE RANGES:

- 0-10 PSI (0-0.7 bar)
- 1-30 PSI (0-2 bar)
- 2-60 PSI (0-4 bar)
- 3-100 PSI (0-6.8 bar)
- 5-150 PSI (0-10.2 bar)
- 10-250 PSI (0.7-17 bar)
- 20-500 PSI (1.4-34 bar)

TUBING AND HOSE



Viking is your source for Stainless Steel Instrumentation tubing!

Stocking standard sizes 1/4", 3/8", 1/2", 3/4" and 1" of stainless steel tubing (seamless or welded) foreign or domestic, we can fulfill your tubing needs today! Viking can also supply copper tubing, as well as exotic alloys such as Monel, Hastelloy and others.

HOSE PRODUCTS

- Pressure Hose
- Fittings & Adapters (stainless steel, steel, brass)
- Hose Assemblies
- PTFE Lined Hose
- NGV Hoses
- Thermo Plastic Hoses
- High Pressure Hoses



INSTRUMENT AND HEAT TRACE TUBING PRODUCTS - FLUID & GAS HANDLING



Chemical Processing & Refineries

- Temptube® - Single Tube Insulated.
- Steam Trace - LT Series Light Trace.
- Steam Trace - HT Series Heavy Trace.
- Electric Trace - Self-Regulating.

Power Generation

- Intermittent High Temperature Steam
Purge-Freeze Protection
- Continuous High Temperature Steam
Purge-Freeze Protection

Process Control and Environmental Monitoring System

- Analyzer Bundles
- Probe Support
- Constant Watt - Low Temperature Maintenance
- Constant Watt - High Temperature Maintenance
- Mineral Insulated - High Temperature Maintenance

Industrial Plant - Robotics - Laboratory

- Multiple Plastic Tube Bundles
- Multitube® - Metal

INTEGRATED SYSTEMS SOLUTIONS

DESIGN & FABRICATION

Give us your toughest applications or even your simplest and we will help you custom design a complete package tailored to your specifications.

- Mass Flow Systems
- Sample Conditioning Systems
- Flow Transmitters
- Stream Switching
- Valve Systems
- Change Over Systems
- Filtration Systems
- Water / Steam Sampling
- Process Sampling
- Cylinder Sampling
- Enclosure / Shelter Systems
- Accessories
- Kitting
- Assembly
- Double Block and Bleed Valves

And much more . . . just ask!!

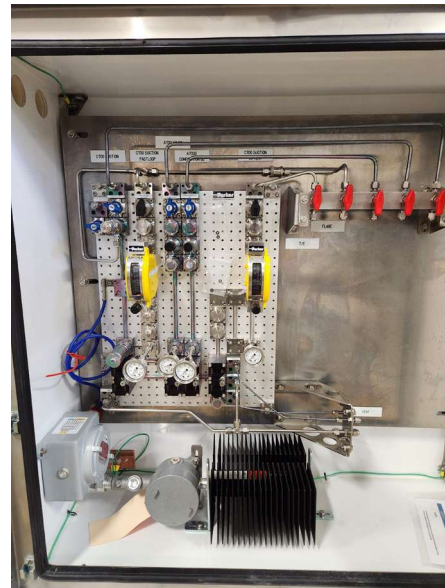

Instrument Box Fabrication

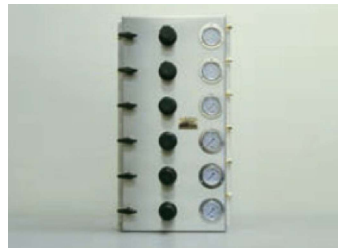

Air Distribution Panels



Chemical Feed Systems



Control Panels

INSTRUMENT CLOSURE BOXES

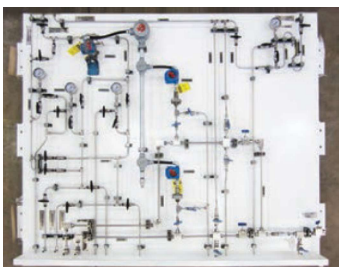

Autoclave - High Pressure Panels



Heated Sample Conditioning Parker Intraflow



VIKING

INSTRUMENT & CONTROL LTD.

Superior Products, Exceptional Service

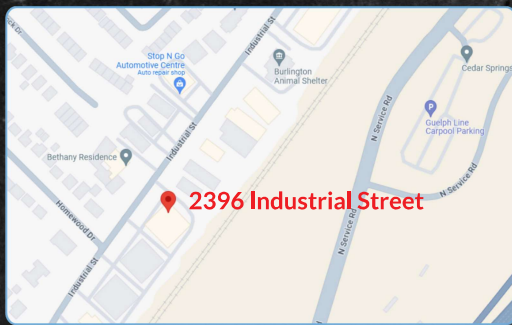

BURLINGTON

2396 Industrial Street
Burlington, Ontario L7P 1A5
905.331.1662
1.800.787.2039

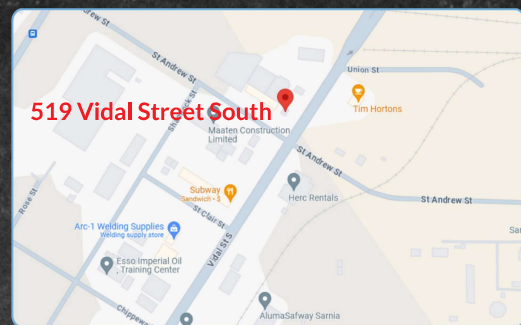

SARNIA

519 Vidal Street South
Sarnia, Ontario N7T 2V5
519.344.5271

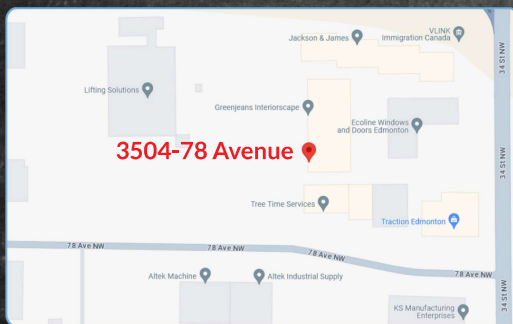

EDMONTON

3504-78 Avenue
Edmonton, Alberta T6B 2X9
587.415.4426
1.877.216.4654

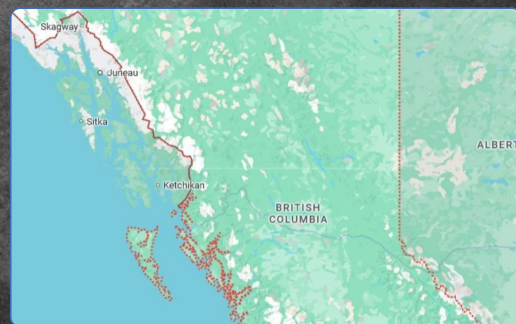

BRITISH COLUMBIA

587.415.4426
1.877.216.4654