

IN-LINE LIQUID FLOW METER INSTALLATION & MAINTENANCE INSTRUCTIONS



FORM # HLIT205-2G

8635 WASHINGTON AVENUE • RACINE, WISCONSIN 53406-3738
TEL. 1-800-HEDLAND • FAX 1-800-CHK-FLOW

CAUTION

This product should be installed and serviced by technically qualified personnel trained in maintaining industrial class flow instrumentation and processing equipment.

CAUTION

Read instructions thoroughly before installing the flow meter. If you have any questions regarding product installation or maintenance call your local supplier for more information.

I. Introduction

The Flow Meter is a rugged industrial class in-line flow rate indicator, offered in Aluminum, Brass or Stainless Steel models, in seven port sizes (from 1/4" to 3") to monitor a wide variety of liquids, in flow ranges from .02-0.2 through 20-300 GPM.

This direct reading piston-type variable area flow meter is simple to install. However, a few precautions are recommended to assure maximum operational reliability with minimum maintenance.

Materials of Construction

The standard In-line Flow Meter is offered in a variety of construction materials to provide flexibility to fit a wide range of flow monitoring applications.

Aluminum is offered as a rugged, low cost flow meter for monitoring noncorrosive water-based or petroleum-based fluids, under operating pressures up to 3500 PSI.

Stainless Steel is offered for monitoring hydraulic systems operating at pressures up to 6000 PSI or other corrosive or caustic fluids, such as acetic acid. For further construction material details see "Fluid Selection Chart".

Fluid Selection Chart

Fluid	Specific Gravity	Correction Factor of Standard Scale		Internal Body Material				External Press. Seals			Dust Guard	
		Oil	Water	Aluminum	Brass	T316 SST	T303 SST	Viton®	EPR	Polycarbonate	Nylon	Pyrex®
Acetic Acid (Air Free)	1.06	0.909	0.971	C	N	R	R	R	R	C	N	R
Acetone	0.79	1.053	1.125	R	R	R	R	N	R	N	R	R
Alcohol Butyl (Butanol)	0.83	1.027	1.098	C	C	R	R	C	R	R	R	R
Alcohol Ethyl (Ethanol)	0.83	1.027	1.098	C	C	R	R	C	R	R	N	R
Ammonia	0.89	0.992	1.060	R	C	R	R	N	R	N	C	R
Benzine	0.69	1.127	1.204	C	R	R	C	R	N	N	R	R
Carbon Disulphide	1.26	0.834	0.891	R	N	R	R	R	N	N	R	R
Castor Oil	0.97	0.950	1.015	C	R	R	C	R	N	C	C	R
Cotton Seed Oil	0.93	0.970	1.037	C	R	R	R	R	N	R	R	R
Ethylene Glycol 50/50	1.12	0.884	0.945	R	R	R	R	R	R	R	C	R
Freon I	1.46	0.774	0.828	R	R	R	R	R	N	R	R	R
Gasoline	0.70	1.119	1.195	R	R	R	R	R	N	C	R	R
Glycerin	1.26	0.834	0.891	R	R	R	R	R	R	R	C	R
Kerosene	0.82	1.033	1.104	R	R	R	R	R	N	R	R	R
Liquid Propane (LPG)	0.51	1.310	1.400	R	R	R	R	R	N	N	R	R
Mineral Oil	0.92	0.976	1.042	R	N	R	R	R	N	R	R	R
Naphtha	0.76	1.074	1.147	R	N	R	R	R	N	C	R	R
Perchloroethylene	1.62	0.735	0.786	C	N	R	R	R	N	N	N	R
Petroleum Oil	0.876	1.000	1.068	R	R	R	R	R	N	R	R	R
Phosphate Ester	1.18	0.862	0.921	R	R	R	R	R	N	N	R	R
Phosphate Ester Base	1.26	0.833	0.891	R	R	R	R	N	R	N	R	R
Phosphoric Acid (Air Free)	1.78	0.701	0.749	N	N	R	R	N	R	N	R	R
Sea Water	1.03	0.922	0.985	N	N	C	C	N	R	R	R	R
Synthetic Petroleum Base	1.00	0.936	1.000	R	C	R	R	R	N	R	R	R
Water	1.00	0.936	1.000	N	R	R	R	R	N	R	R	R
Water Glycol 50/50	1.07	0.905	0.967	R	R	R	R	R	R	N	R	R
Water-in-oil	0.93	0.970	1.037	R	R	R	R	R	N	R	R	R

R - Recommended N - Not Recommended C - Consult Factory

CAUTION

Oil Meters are not recommended for water monitoring applications. If meter is to be subjected to both oil and water, water meters (Brass) are suggested. Consult factory for details.

Brass is recommended for water monitoring applications or other systems where corrosion inhibitors are not present.

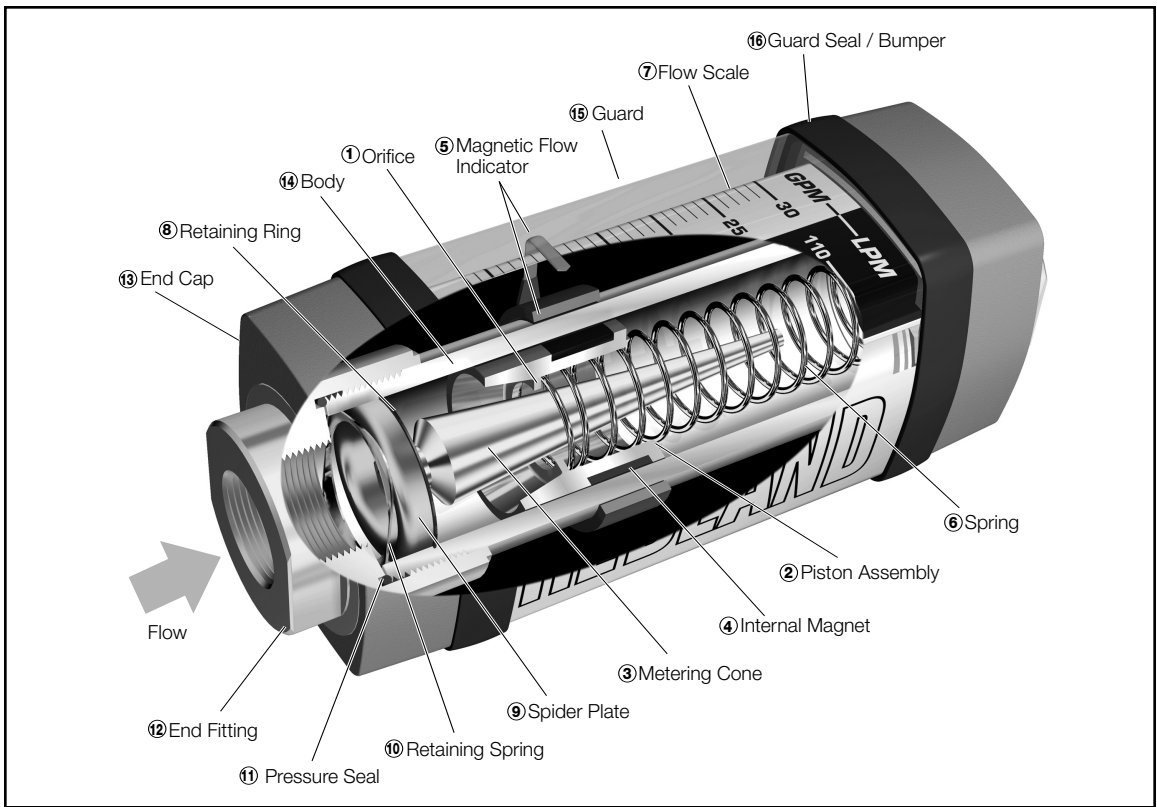

⚠ CAUTION

This meter may contain residual amounts of test fluid at the time of shipment. This fluid should be removed prior to installation as the fluid may be incompatible or hazardous with some liquids or gases. Failure to follow these instructions could result in damage to the equipment.

II. Operating Principle:

The Flow Meter is a variable area instrument. A sharp-edged Orifice ① located within the Piston Assembly ②, forms an annular opening with the contoured Metering Cone ③. The piston assembly carries a cylindrical PPS/Ceramic Magnet ④ that is magnetically coupled to an external Indicating Magnet ⑤ that moves precisely, in direct response to movement of the piston. A calibrated Spring ⑥ opposes flow in the forward direction. This spring decreases viscosity sensitivity and allows the flow meter to be used in any position, including inverted.

Bi-directional flow capability: If required, a reverse flow by-pass option is available and is depicted on individual product pages of Hedland catalog Form No. 140-2G. Note that flow is measured in the forward direction only.

Operates in any position: The in-line flow meter's unique spring loaded variable area design allows meters to be installed in any position without affecting accuracy. An optional inverted flow scale is also available.

Easier to read linear scale: This flow meter is the most readable product in its class. Brightly colored indicators move over the graduated, linear Flow Scale ⑦ which contains bold, easy to read numerals and gauge marks. This enhanced resolution virtually eliminates parallax problems associated with competitive, direct reading flow meters.

360° Rotatable guard/scale: This unique design allows the meter to be installed in any orientation without regard to scale direction. Once the meter is permanently installed, the guard/scale can be rotated 360° to optimize readability.

Standard Flow Scale

Calibrated in graduated GPM and LPM at a specific gravity of 0.876 for oil or other petroleum-based fluids, 1.0 for water or other water-based fluids, or 1.18 for phosphate ester liquids. For convenient field conversion of the standard flow scale to other fluids, see the "Fluid Selection Chart" on page 1.

Operating Pressure

The standard Flow Meter (Aluminum and/or Brass) operates under normal industrial class conditions at pressures up to 3500 PSI (800 PSI for 3" meters) with a 3:1 safety factor. Stainless Steel models are rated up to 6000 PSI with a 3:1 safety factor.

! CAUTION

For rigorous cyclical applications, consult factory for specific fatigue life estimates.

Operating Temperature

Standard Hydraulic Oil Flow Meters (Aluminum), Water Flow Meters (Brass) and Water-based (Aluminum) Flow Meters have an operating temperature rating of 240 °F maximum.

Pressure vs. Temperature

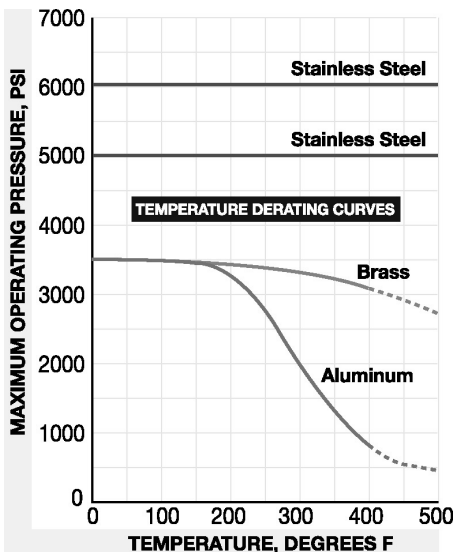

—— CONTINUOUS TEMPERATURE
----- INTERMITTENT TEMPERATURE

High Temperature Flow Meters (both oil and/or water-based fluids models) are rated to operate continuously at 400 °F or intermittently at temperatures up to 500 °F. See "Pressure vs. Temperature" Chart.

! CAUTION

Operating at elevated temperatures reduces the flow meter's pressure rating.

Fluid Velocity & Acceleration

We recommend that you maintain fluid velocity at 25 ft/sec or less. However, applications vary and higher velocities may be suitable for your specific application.

III. Installation

The In-line Flow Meter is a simple device to install. However, the following tips are recommended for reliable, trouble-free operation.

! CAUTION

Do NOT install this unit within 2 ft. of electrical transformers, high powered electric motors or other electromagnetic devices that could adversely affect the magnetic coupling between the flow indicator ring and the piston magnet.

A. Piping (plumbing)

1. The standard In-line Flow Meters are offered in SAE (Society of Automotive Engineers), NPTF (National Pipe Thread - Dry Seal), and BSPP (British Standard Pipe Parallel) ports and available in the following sizes: 1/4" (SAE #6), 1/2" (SAE #10), 3/4" (SAE #12), 1" (SAE #16), 1-1/4" (SAE #20), 1-1/2" (SAE #24), 1-1/2" Code 62 4-bolt flange, 3" and 3" Code 61 4-bolt flange. Note: Use pipe threaded within commercial tolerances.

! CAUTION

Do NOT use aromatic hydrocarbons, halogenated hydrocarbons, ketones or ester-based fluids on (or near) polycarbonate guard. Do NOT use Loctite® thread locker or liquid Teflon® as thread sealant.

2. Piping should be accurately aligned and of correct length. The high pressure body of the flow meter can withstand shock and flow/pressure pulsation. However, the piping should be firmly supported by external mounting brackets, both upstream and downstream of the meter, to avoid any pipe flexing action that could reduce the life of the meter.
3. If the flow meter inlet or outlet are to be rigidly mounted and the opposing port is to be connected to flexible hose, the end connected to flexible hose *must* be rigidly mounted.
4. Install a union near the inlet or outlet of the meter. This will facilitate quick, easy meter removal and inspection during periodic maintenance procedures.

CAUTION

Do not use pipe wrenches on the flow meter body. To avoid scarring or otherwise damaging the external surface, use an open end wrench for securing the inlet and for tightening the flow meter outlet connection port.

5. The In-line Flow Meter does not require flow straighteners or special lengths of straight inlet/outlet piping to stabilize turbulent flow patterns. However, to assure maximum operational reliability, avoid installation of elbows, valves and/or reducers immediately adjacent to the meter inlet, if possible.

B. Flow Direction

Caution should be taken to align the flow arrow, located on the meter scale, in the same direction as the anticipated line flow.

CAUTION

The standard flow meter is a unidirectional flow meter. The piston acts as a check valve to block flow in the reverse direction. This causes an excessive pressure differential, which can result in damage to internal meter components. The flow meter is also available in a modified design, which offers a reverse flow by-pass feature to accommodate bi-directional flow. Consult factory for details.

C. Mounting Orientation

The design of the In-line Flow Meter provides the designer/installer the flexibility to mount the product in any plane, without sacrificing (hindering) flow rate accuracy. (It is calibrated in the horizontal axis, and will provide the highest degree of accuracy in that orientation.)

D. Filtration

The meter will allow particulate to pass that would jam most valves and flow controls. Systems which do not have filtration should be equipped with at least a 200 mesh sieve or 74 micron filter. Most hydraulic systems would already have a much finer filtration.

Within the flow meter body, dirt, ferrous metal or sealing agents, such as Teflon® tape may lodge and cause malfunction. If the meter is jammed at a fixed position, follow cleaning instructions.

E. Cleaning and Maintenance

CAUTION

Before attempting to remove the meter from the line, check the system to confirm that line pressure has been reduced to zero PSI.

CAUTION

Review precautions listed under "A. Piping" prior to removing meter from line.

1. Remove flow meter from line. Remove excess piping from meter. NOTE: It is *NOT* necessary to remove the transparent dust guard from the meter to remove the meter from the line.

CAUTION

Do NOT use cleaning solvent on the transparent guard!

2. Thoroughly wipe off the entire flow meter surface, removing all foreign matter.

3. If you choose to remove the dust guard assembly, see Procedure A below.
 4. Remove the inlet cap from the flow meter body, noting the sequence of disassembly for later reference (during reassembly). **The internal parts are held in place by a retaining ring. Remove the retaining ring.** The wetted parts *should* slide out when the meter is tilted. If they **DO NOT** slide out freely, read Procedure B before proceeding.
 5. Place all meter components on a clean work surface in order of disassembly.
 6. Clean and dry the spring and meter body, checking outlet port threads for foreign particles.
 7. Inspect piston and ring magnet assembly. Check magnet for hairline cracks. Clean, dry and reassemble.
 8. Clean inlet spider cap and metering cone assembly.
 9. Reassemble the flow meter, checking the inlet cap O-ring for nicks and cuts. If nicks and cuts are present, the O-ring should be replaced.
- b. Take corrective action to resolve the problem (install finer filtration unit, etc.).
3. Check for scored or worn parts, especially the outer diameter of the piston assembly. Also check the inner surface of the flow meter body.
 - a. Replace any badly worn parts.
 - b. Return the flow meter to the factory for detailed inspection and repair.

Procedure C – Quick Recoupling

This piston-type variable area flow meter is inherently less sensitive to shock and vibration than other variable area designs. The unique magnetic coupling also eliminates the need for mechanical linkages that can wear or loosen over the functional life of the meter.

However, on occasion, a pressure spike or extreme flow surge can cause the piston to move in reverse motion at such rapid speed that it disconnects the piston (magnetic coupling) from the external magnetic indicator ring. If this occurs, we suggest the following procedures to recouple the piston magnet and the external indicator ring.

1. If the system permits, simply fluctuate flow rate from “no flow” to “full flow” allowing the moving piston to magnetically recouple to the indicator ring.
2. For rigorous cyclical applications where this decoupling may occur frequently, consult the technical services staff for further recommendations.

For parts numbers and other details, see “Price and Availability Digest”, Form 141 on CD-ROM.

Procedure A – Removal of Dust Guard

To remove the dust guard for cleaning or replacement, simply loosen the end fitting located at the bottom of the meter and slide the end cap, dust bumper, and the dust guard off the bottom of the meter, taking care to avoid damaging the O-ring seal between the end cap and the dust gland.

Procedure B – Service Inspection/Replacement

1. If internal wetted parts do not slide freely out of the flow meter body, they may be pushed out by inserting a wooden dowel into the outlet port of the meter. (Make sure the retaining ring has been removed.)
2. After disassembly, check for foreign matter on the wetted parts and on the inner surface of the flow meter body.
 - a. Isolate and identify the source of the foreign matter.

Petroleum Fluids

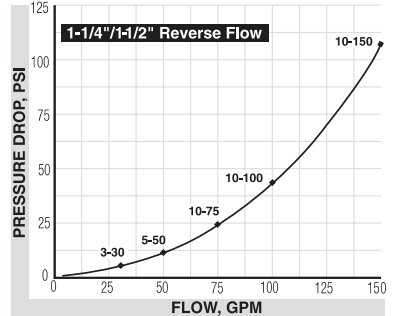
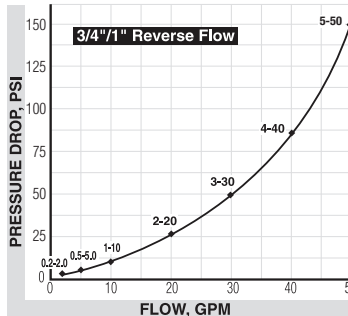
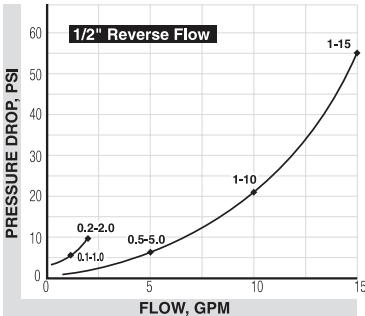
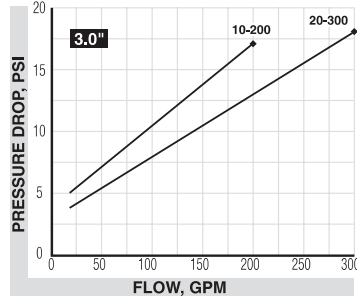
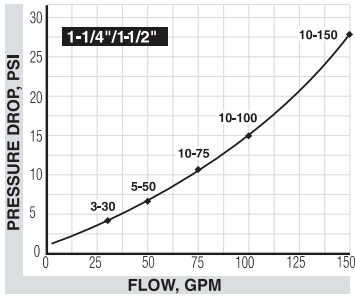
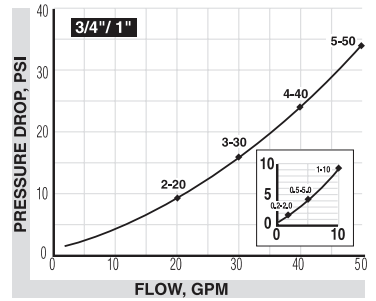
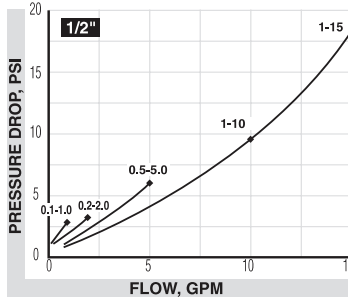
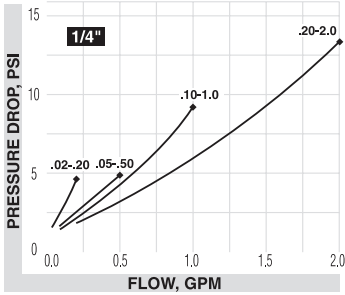

Phosphate Ester

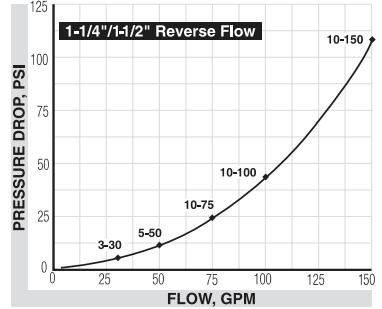
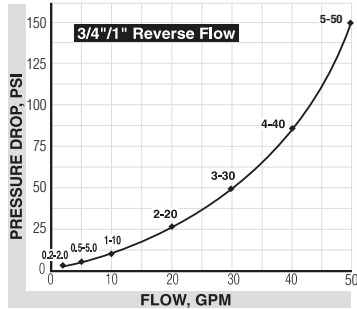
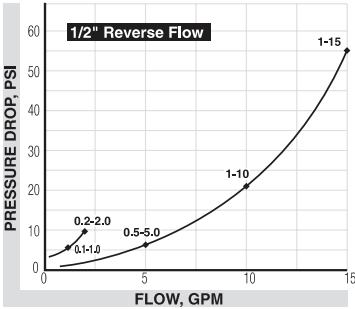
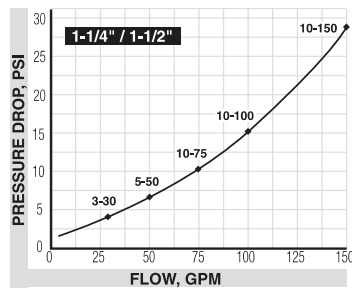
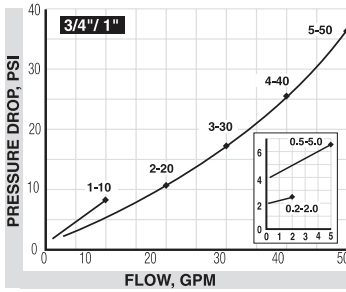
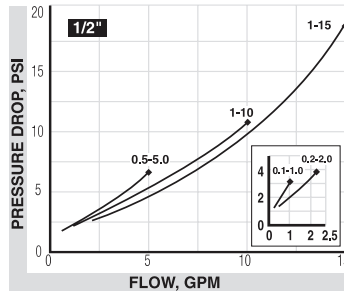
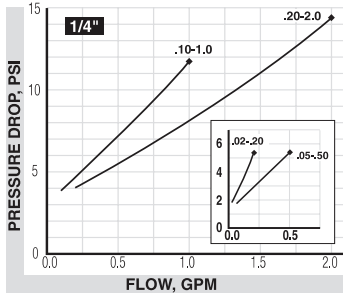

Water-based Fluids

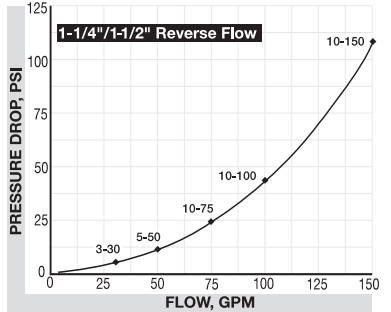
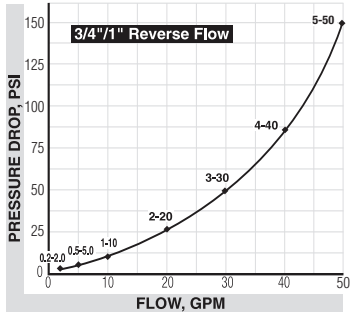
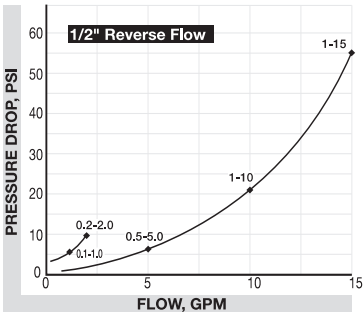
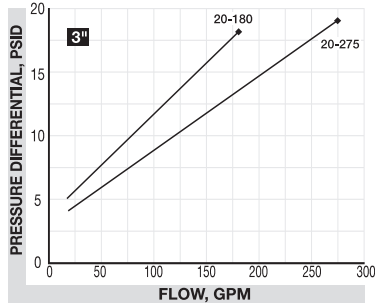
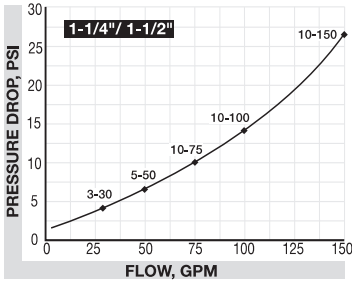
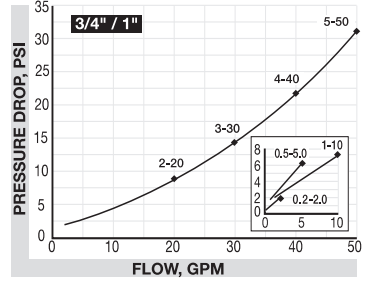
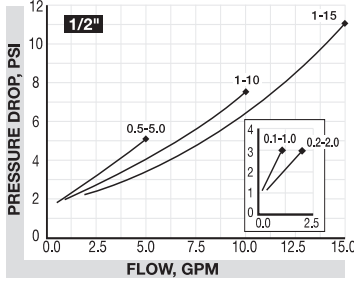
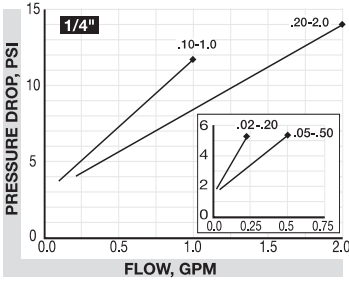

Water

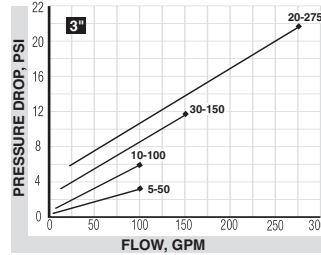
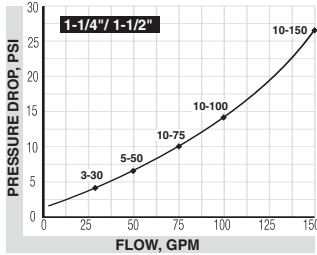
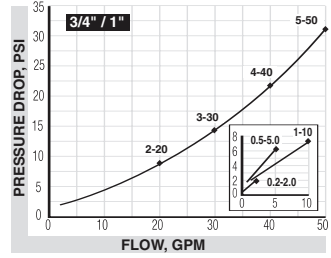
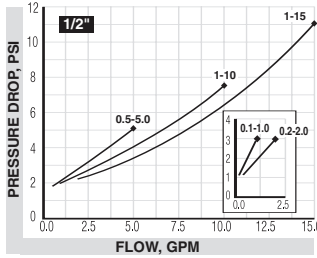
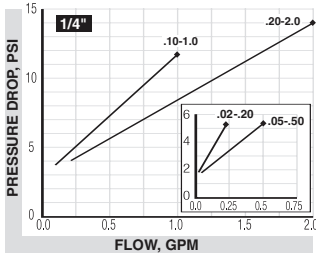

Caustic and Corrosive Liquids

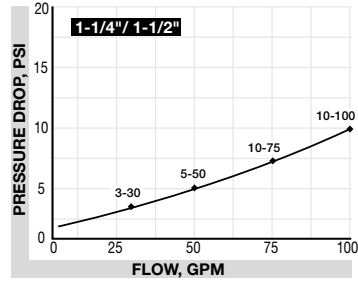
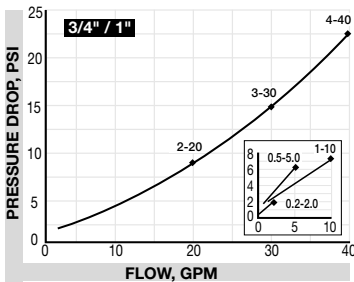
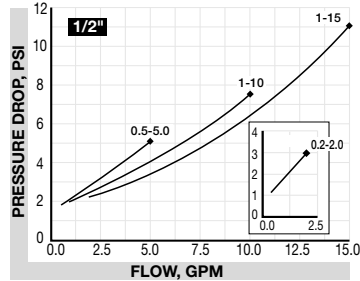
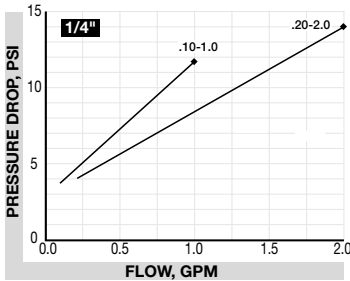

A.P.I. Oil

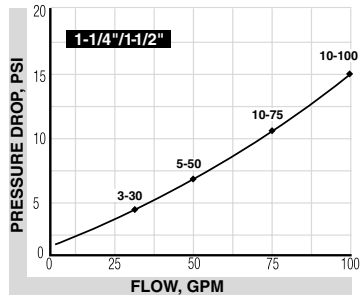
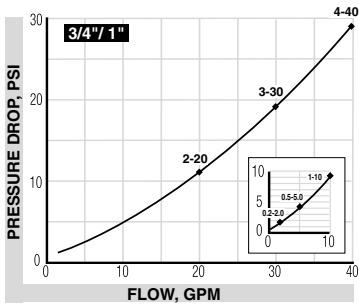
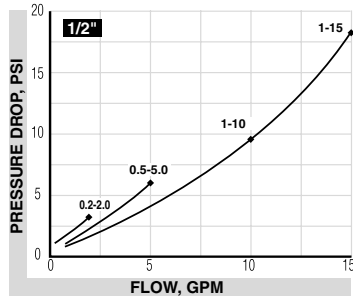
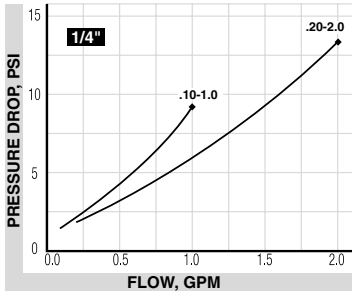

STANDARD METER

DIMENSIONS: (1/4 to 1-1/2 Series)

A	B	C	D	E	F
NOMINAL PORT SIZE	LENGTH in (mm)	WIDTH in (mm)	DEPTH in (mm)	OFFSET in (mm)	FLATS in (mm)
1/4 (SAE 6)	4.8 (122)	1.68 (43)	1.90 (48)	.84 (21)	.88 (22)
1/2 (SAE10)	6.6 (168)	2.07 (53)	2.40 (61)	1.04 (26)	1.25 (32)
3/4 (SAE 12)	7.2 (183)	2.48 (63)	2.85 (72)	1.24 (32)	1.50 (38)
1 (SAE 16)	7.2 (183)	2.48 (63)	2.85 (72)	1.24 (32)	1.75 (44)
1-1/4 (SAE 20)	12.2 (310)	4.12 (105)	4.72 (120)	2.06 (52)	2.75 (70)
1-1/2 (SAE 24)	12.2 (310)	4.12 (105)	4.72 (120)	2.06 (52)	2.75 (70)

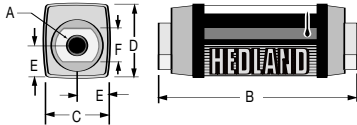

HIGH TEMPERATURE METER

DIMENSIONS: (1/4 to 1-1/2 Series)

A	B	C	D
NOMINAL PORT SIZE	LENGTH in (mm)	WIDTH in (mm)	FLATS in (mm)
1/4 (SAE 6)	6.60 (168)	2.01 (53)	1.25 (32)
1/2 (SAE10)	6.60 (168)	2.01 (53)	1.25 (32)
3/4 (SAE 12)	7.20 (183)	2.48 (63)	1.50 (38)
1 (SAE 16)	7.20 (183)	2.48 (63)	1.75 (44)
1-1/4 (SAE 20)	12.20 (310)	4.20 (105)	2.75 (70)
1-1/2 (SAE 24)	12.20 (310)	4.20 (105)	2.75 (70)

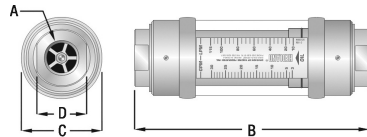

1-1/2 CODE 62, 4-BOLT FLANGE

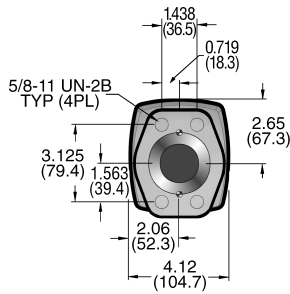
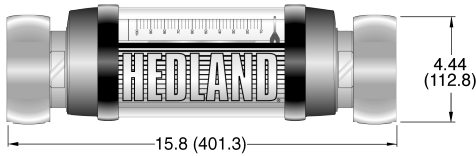

3 INCH, SAE, NPTF, BSPP

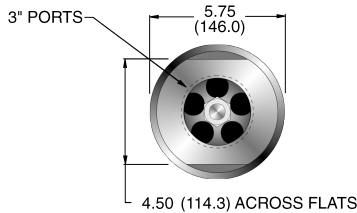
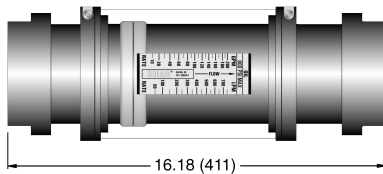

3 INCH CODE 61, 4-BOLT FLANGE

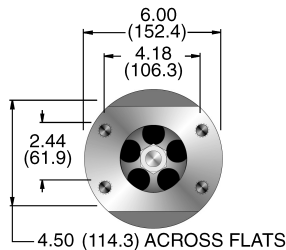
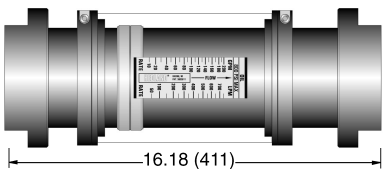

HEDLAND

Division of Racine Federated Inc.

Limited Warranty and Disclaimer

Hedland, Division of Racine Federated Inc. warrants to the end purchaser, for a period of one year from the date of shipment from the factory, that all flow meters manufactured by it are free from defects in materials and workmanship. This warranty does not cover products that have been damaged due to misapplication, abuse, lack of maintenance, or improper installation. Hedland's obligation under this warranty is limited to the repair or replacement of a defective product, at no charge to the end purchaser, if the product is inspected by Hedland and found to be defective. Repair or replacement is at Hedland's discretion. A returned goods authorization number must be obtained from Hedland before any product may be returned for warranty repair or replacement. The product must be thoroughly cleaned and any process chemicals removed before it will be accepted for return.

The purchaser must determine the applicability of the product for its desired use and assumes all risks in connection therewith. Hedland assumes no responsibility or liability for any omissions or errors in connection with the use of its products. Hedland will under no circumstances be liable for any incidental, consequential, contingent or special damages or loss to any person or property arising out of the failure of any product, component or accessory.

All expressed or implied warranties, including **the implied warranty of merchantability and the implied warranty of fitness for a particular purpose or application are expressly disclaimed** and shall not apply to any products sold or services rendered by Hedland.

The above warranty supersedes and is in lieu of all other warranties, either expressed or implied and all other obligations or liabilities. No agent or representative has any authority to alter the terms of this warranty in any way.

HEDLAND®

DIVISION OF RACINE FEDERATED INC.

8635 Washington Avenue, Racine, WI 53406-3738

Telephone 262-639-6770 or 1-800-HEDLAND

Fax 262-639-2267 or 1-800-CHK-FLOW

www.hedland.com

Materials & specifications are subject to change without notice.

Hedland is a registered trademark of Racine Federated Inc.

Viton is a registered trademark of DuPont Dow Elastomers.

Teflon is a registered trademark of E.I. du Pont de Nemours and Company.

Pyrex is a registered trademark of Corning Glass Works Corporation.

Loctite is a registered trademark of Henkel Loctite Corporation.